

CODING EXAMPLE

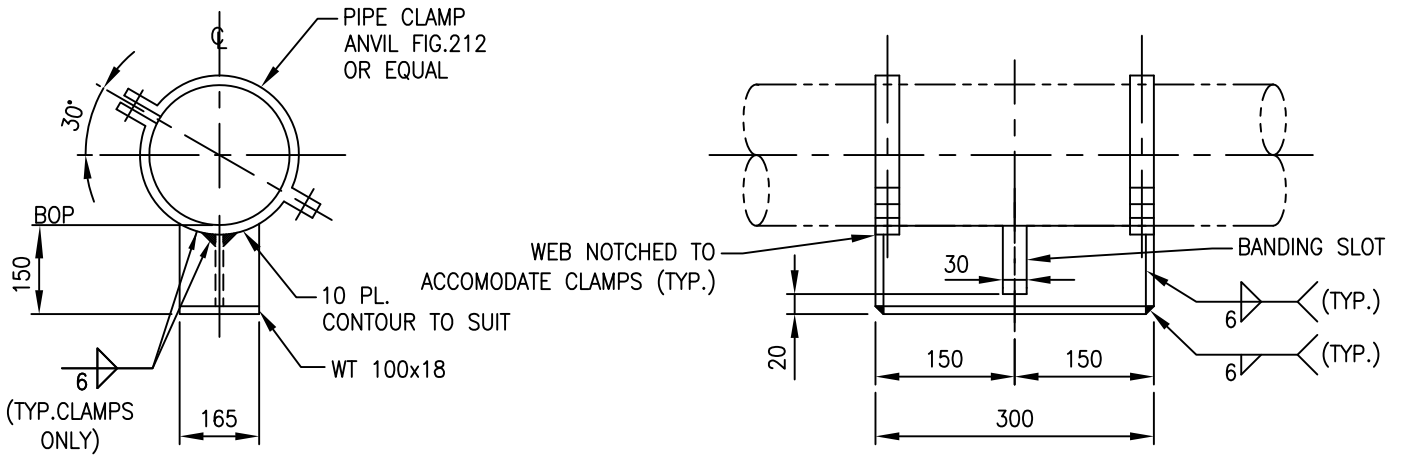
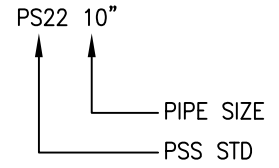

NOTES

1. CLAMP SHOE MATERIAL IS CARBON STEEL CSA G40.21 GR.300W.
2. BOLTING MATERIAL A325, A563 NUT AND WASHER.
3. FOR ALL NON CS PIPING (ALLOY, FRP, PLASTIC) A 3mm THK THERMOFAB LINER OR EQUAL MUST BE WRAPPED AROUND THE PIPE AT THE CLAMP CONTACT POINTS.

0	ISSUED FOR CONSTRUCTION					
REV	REVISION	DATE	DRN	CHK	ENG	APP
CLIENT	TITLE PIPE SUPPORT STANDARD CLAMPED PIPE SHOE 150 mm HIGH NPS 10" TO NPS 12" PS22					
PREPARED BY	SCALE N.T.S.	DWG. No. PSS-PS22	CLIENT DWG. No.	PROJ.	REV. 0	